

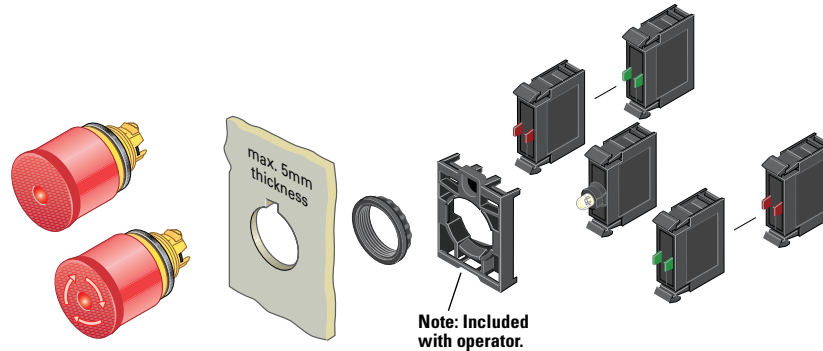

## Illuminated Emergency Stops



### Components

#### Operators Only <sup>①</sup>

	Type	Color	Actuator Size	Catalog Number
<b>M22-PVL</b> 	Push-pull	Red	35 mm	<b>M22-PVL</b>
		Black	35 mm	<b>M22S-PVL</b>
<b>M22S-PVLT</b> 	Twist-to-release	Red	35 mm	<b>M22-PVLT</b>
			45 mm	<b>M22-PVLT45P</b>
			60 mm	<b>M22-PVLT60P</b>
		Black	35 mm	<b>M22S-PVLT</b>

#### M22-LED-W



#### Light Units <sup>②</sup>

Terminal Type	LED Color	Light Unit Voltage	Catalog Number
Screw	White	12–30 Vac/Vdc	<b>M22-LED-W</b>
	Red	12–30 Vac/Vdc	<b>M22-LED-R</b>
Screw	White	85–264 Vac	<b>M22-LED230-W</b>
	Red	85–264 Vac	<b>M22-LED230-R</b>
Screw	White	207–264 Vac	<b>M22-LED230H-W</b>
	Red	207–264 Vac	<b>M22-LED230H-R</b>





#### M22-K10



#### Contact Blocks <sup>②</sup>

Terminal Type	Contact Configuration <sup>③</sup>	Catalog Number
Screw	NO	<b>M22-K10</b>
	NO, early-make	<b>M22-K10P</b>
	NC	<b>M22-K01</b>
	NC, late-break	<b>M22-K01D</b>
Spring-cage	NO	<b>M22-CK10</b>
	NC	<b>M22-CK01</b>
	NC, late-break	<b>M22-CK01D</b>
	2NO	<b>M22-CK20</b>
	2NC	<b>M22-CK02</b>
	NO-NC	<b>M22-CK11</b>

#### Accessories

Description	Voltage	Catalog Number
<b>M22-XGPV</b> 	—	<b>M22-XGPV</b>
<b>M22G-XGPV</b> 	—	<b>M22G-XGPV</b>
<b>M22-MGTA</b> 	—	<b>M22-MGTA</b>
<b>M22-PL-PV</b> 	—	<b>M22-PL-PV</b>
Illuminated ring	24 Vac/Vdc	<b>M22-XPV60-Y-24</b>
	120 Vac	<b>M22-XPV60-Y-120</b>
	230 Vac	<b>M22-XPV60-Y-230</b>

#### Notes

- ① Includes contact block mounting adapter.
- ② For complete listing of available light units and contact blocks, see Accessories, **Pages V7-T1-96 to V7-T1-101**.
- ③ All NC contact blocks are positively driven contact. (⊖)

Approximate Dimensions in Inches (mm)

### Illuminated Pushbuttons

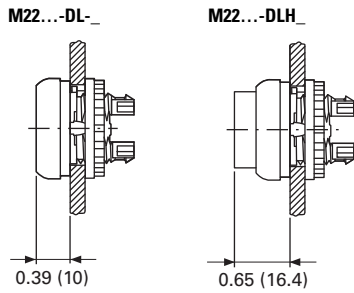

### Mushroom Head Pushbutton

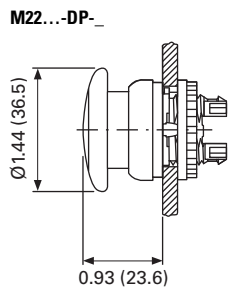

### Emergency-Stop Operators

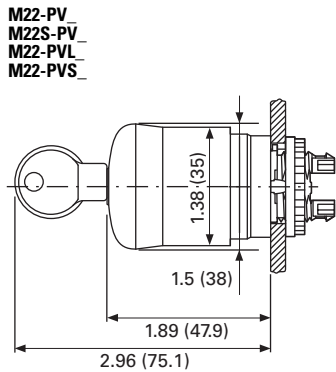

### Potentiometer

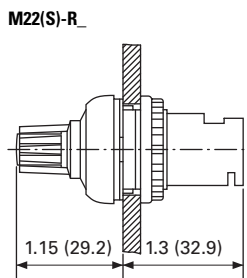

### Contact Block Mounting Adapter

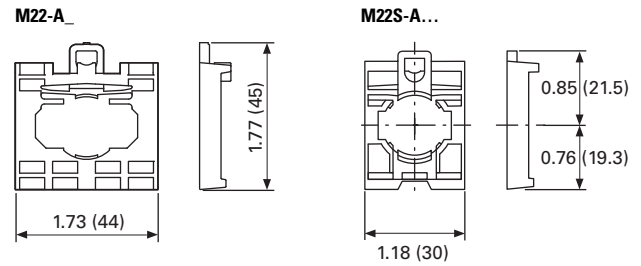

### Front Mounted Centering Adapter

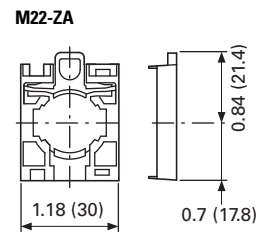

### Front Mounted Indicating Light

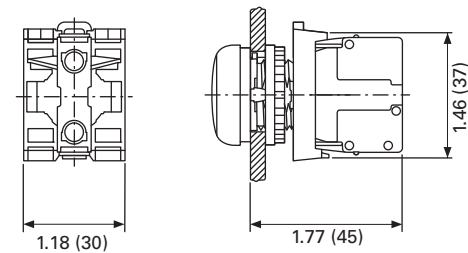

### Pushbutton, Complete Devices

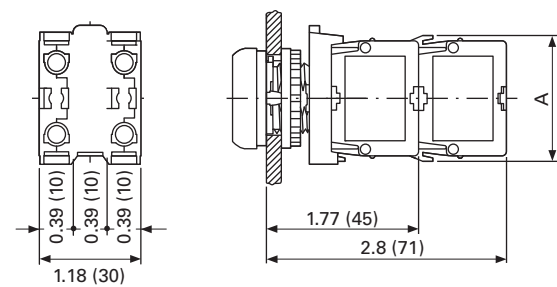

	1 x M22-K_	2 x M22-K_	1 x M22-CK_	2 x M22-CK_
<b>A</b>	1.46 (37.2)	1.46 (37.2)	1.54 (39.0)	1.54 (39.0)