

Emergency Stops

Product Description

Eaton’s M22 emergency stops are a durable and reliable solution to a variety of e-stop applications. With standard push-pull, as well as twist-to-release and key-release, illuminated options and red or black operators,

the M22 e-stop is a robust solution. As with all operators, they can be ordered as a ready to install complete device or as modular components for the perfect fit.

Features

- Push-pull and twist to release options available as well as illuminated and keyed release
 - LED offering only for improved brightness quality and up to 100,000 hours of operation
 - More than 100,000 mechanical operations
 - Capable of communicating via ASi protocol with ASi adapter modules
- Protection Type**
- IP67, IP69K (IP66 key-release)
 - NEMA 4X, 13

Catalog Number Selection

Catalog Number Selection is for illustrative purposes only and not to be used to create new catalog numbers.

Emergency Stops

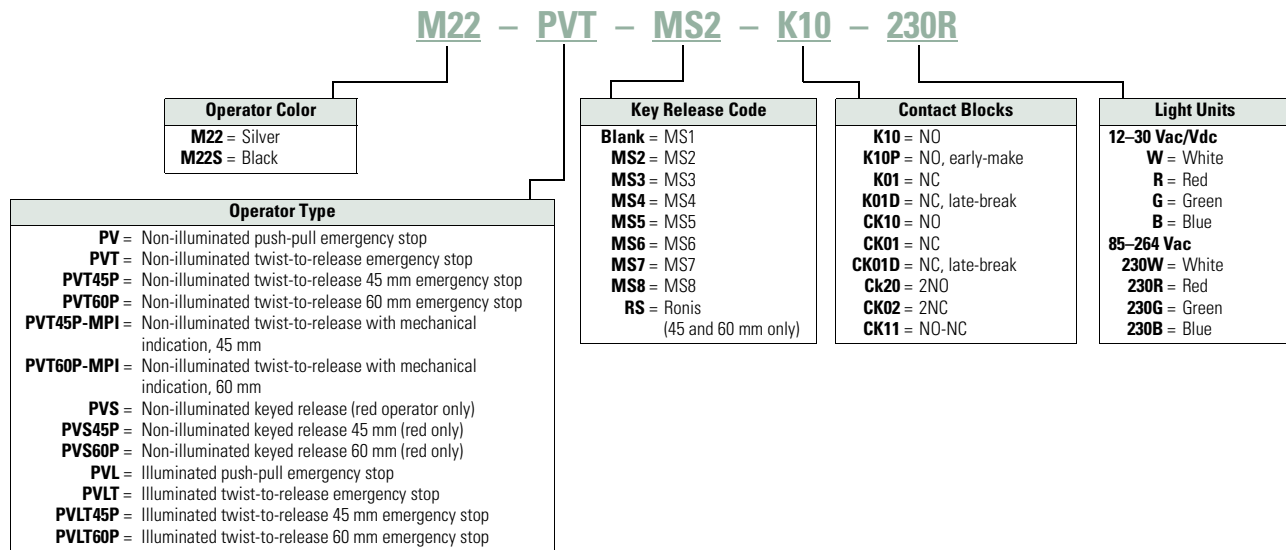

Product Selection

Non-Illuminated Emergency Stops

M22-PV-K01



Complete Devices

Type	Color	Contact Block Configuration ^①	Catalog Number
Push-pull	Red	NC	M22-PV-K01
		2NC	M22-PV-K02
		1NO-2NC	M22-PV-K12
Twist-to-release	Red	NC	M22-PVT-K01
		2NC	M22-PVT-K02
		1NO-2NC	M22-PVT-K12
Key release	Red	NC	M22-PVS-K01
		2NC	M22-PVS-K02
		1NO-2NC	M22-PVS-K12

Note

^① All NC contact blocks are positively driven contact. ⊖

Approximate Dimensions in Inches (mm)

Illuminated Pushbuttons

M22...-DL_

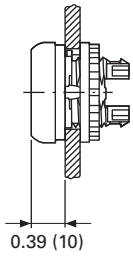

M22...-DLH_

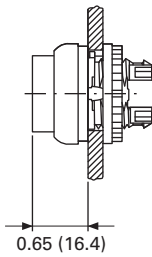

Mushroom Head Pushbutton

M22...-DP_

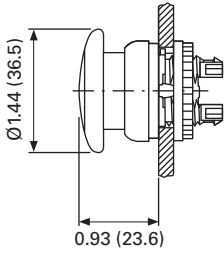

Emergency-Stop Operators

M22-PV_
M22S-PV_
M22-PVL_
M22-PVS_

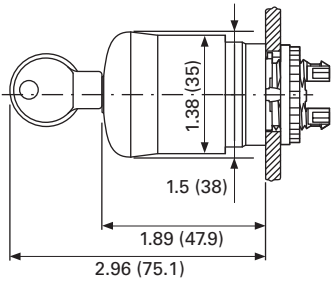

Potentiometer

M22(S)-R_

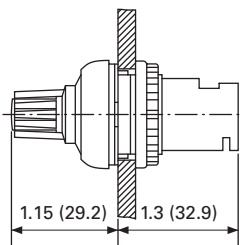

Contact Block Mounting Adapter

M22-A_

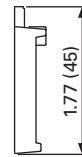
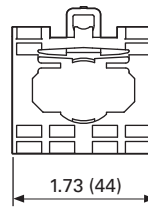

M22S-A...

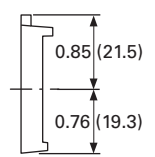
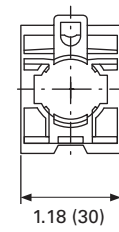

Front Mounted Centering Adapter

M22-ZA

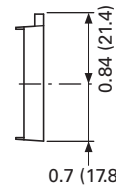
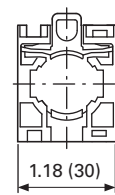

Front Mounted Indicating Light

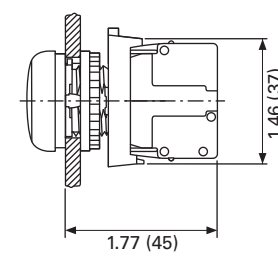
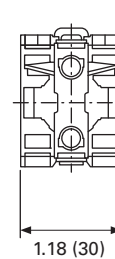

Pushbutton, Complete Devices

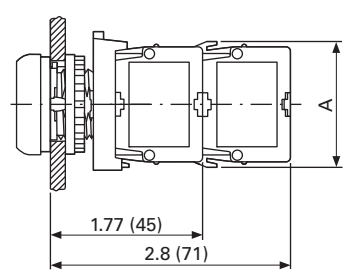
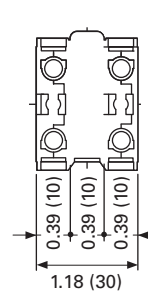

	1 x M22-K_	2 x M22-K_	1 x M22-CK_	2 x M22-CK_
A	1.46 (37.2)	1.46 (37.2)	1.54 (39.0)	1.54 (39.0)